



产品说明书

SPECIFICATIONS

深紫外 LED @ $I_f = 40 \text{ mA}$

UVC-LED @ $I_f = 40 \text{ mA}$

TYPE NO: L280-QSC1F20M001-120°

湖北深紫科技有限公司

Hubei DUVTEK Co., LTD.

www.duvtek.com

No.1, Phoenix Avenue, Indus Lake New District, Ezhou, Hubei, China

Tel: +(86) 15623097174 (sales)

1 产品特性

1 Features

- 峰值波长: 280 nm
- 封装体外型尺寸: $3.7 \times 3.7 \times 1.5$ (L \times W \times H) [单位 : mm]
- 出光角: Typical 120°
- Lighting Color (Peak Wavelength): 280 nm
- Surface Mount Type LED Package: $3.7 \times 3.7 \times 1.5$ (L \times W \times H) [Unit : mm]
- Viewing Angle (Directivity): Typical 120°

2 灯珠产品示意图 (单位: mm)

2 Mechanical Specifications and Materials (Unit: mm)

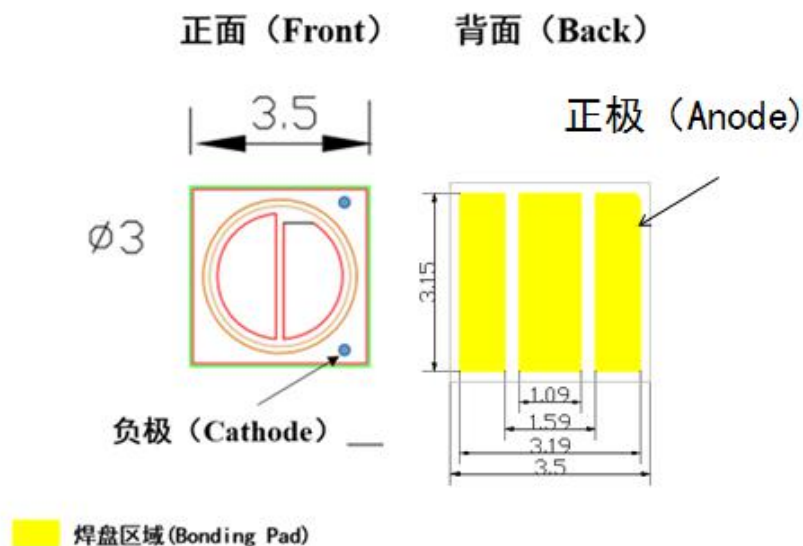

Front

Back

Tolerances unless otherwise mentioned are ± 0.10 mm

除非另有说明，公差为 ± 0.10 毫米



3 应用领域

杀菌消毒，医用光疗，荧光光谱检测，光学传感器，生物分析/检测，防伪检测等。

3 Applications

Disinfection, Phototherapy, Fluorescent Spectroscopy, Sensor Light, Bio-Analysis / Detection, Counterfeit Detectors, etc.

4 光电特征参数(Ta = 25 °C)

4 Typical Optical-Electrical Characteristics (Ta = 25 °C)

Item	Symbol	Unit	L280-QSC1F20M001-120°
峰值波长 Peak Wavelength	λ_p	nm	270 ~ 280
辐射功率 Radiant Flux	P_0	mW	2.0 ~ 4.0
半波宽 Full Width at Half Maximum	$\Delta\lambda$	nm	12
驱动电流 Forward Current	I_f	mA	40
工作电压 Forward Voltage	V_f	V	5.0 ~ 7.0
出光角 Viewing Half Angle	$2\theta_{1/2}$	deg.	120
热阻 Thermal Resistance	$R_{\theta j-b}$	°C/W	~18
最大工作电流 Max Forward Current	I_{fmax}	mA	/

※ 数值由光谱分析仪和积分球测量系统测量。公差如下：

- 正向电压 (V_f) : $\pm 2\%$
- 辐射通量 (Φ_e) : $\pm 10\%$
- 峰值波长 (λ_p) : $\pm 3.0nm$

※ These values measured by Optical spectrum analyzer and integrating sphere measuring system. And tolerances are followings as below:

- Forward Voltage (V_f): $\pm 2\%$
- Radiant Flux (Φ_e): $\pm 10\%$
- Peak Wavelength (λ_p): $\pm 3.0nm$

※ 所有数据均是基于深紫科技测试仪器得到的结果，但根据测试设备的条件，某些值可能会略有不同。

※ Although all LEDs are tested by our equipment, some values may vary slightly depending on the conditions of the test equipment.

5 储存及使用环境条件

5 Absolute Maximum Ratings

Item	Symbol	Unit	Value
使用环境温度 Operating Temperature	T _{OPR}	°C	-40 ~ +60
储存环境温度 Storage Temperature	T _{STG}	°C	-40 ~ +100

※ 超出上述最大额定值操作，可能会影响器件的可靠性并造成永久性损坏。

※ Operating the DUV-LED beyond the listed maximum ratings may affect device reliability and cause permanent damage. These or any other conditions beyond those indicated under recommended operating conditions are not implied. The exposure to the absolute maximum rated conditions may affect device reliability.

※ DUV-LED 不可以反向偏压驱动。

※ The DUV-LEDs are not designed to be driven in reverse bias.

6 典型光电参数图例

6 Typical Electro-Optical Characteristics

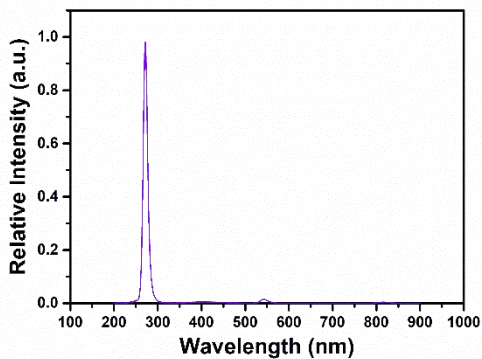

Relative Intensity vs Peak Wavelength
($I_f = 40 \text{ mA}$, $T_a = 25 \text{ }^\circ\text{C}$)

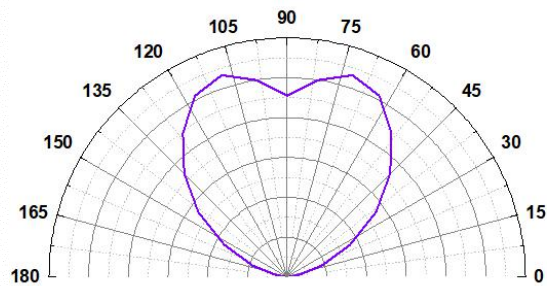

Radiation Pattern
($I_f = 40 \text{ mA}$, $T_a = 25 \text{ }^\circ\text{C}$)

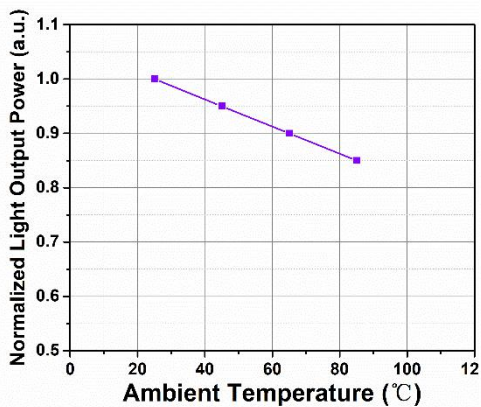

Normalized Light Output Power vs Ambient Temperature ($I_f = 40 \text{ mA}$)
无散热条件下测试

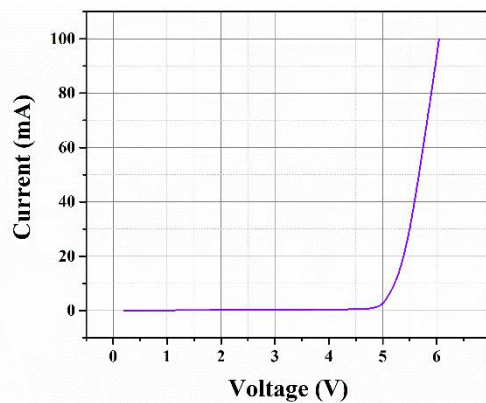

Forward Current vs. Forward Voltage
($T_a = 25 \text{ }^\circ\text{C}$)
由于芯片特性不同，以上数据仅供参考

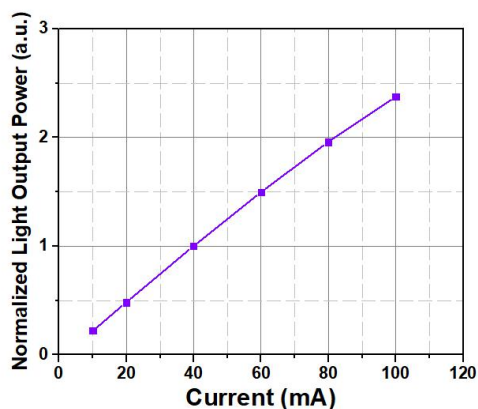

Normalized Light Output Power vs Current
($T_a = 25 \text{ }^\circ\text{C}$)
驱动电流与归一化光功率的关系

7 使用注意事项

7 Cautions on Use

7.1 防潮封装注意事项

7.1 Moisture-Proof Package

- 在焊接过程中，SMD 封装中的湿气可能蒸发并膨胀。
- 湿气会损坏深紫外 LED 的光学特性。
- The moisture in the SMD package may vaporize and expand during soldering.
- The moisture can damage the optical characteristics of the DUV-LEDs due to the encapsulation.

7.2 使用条件

7.2 During Usage

- LED 应避免直接接触有害物质，如硫磺，氯气，邻苯二甲酸盐等。
- 在操作和储存期间必须避免暴露于腐蚀性气体。
- 镀银金属部件不仅受到最终产品内部排放的腐蚀性气体的影响，还受到外部环境渗透的气体的影响。
- 必须避免可能导致冷凝的突发环境温度变化或高湿度等极端环境。
- The LED should avoid direct contact with hazardous materials such as sulfur, chlorine, phthalate, etc.
- The metal parts on the LED can rust when exposed to corrosive gases. Therefore, exposure to corrosive gases must be avoided during operation and storage.
- The silver-plated metal parts also can be affected not only by the corrosive gases emitted inside of the end-products but by the gases penetrated from outside environment.
- Extreme environments such as sudden ambient temperature changes or high humidity that can cause condensation must be avoided.

7.3 清洗注意事项

7.3 Cleaning

- 请勿使用刷子清洗或用有机溶剂（即丙酮，TCE 等）进行清洗，否则可能会损坏 LED 的树脂。

- 在以下条件下，异丙醇（IPA）是推荐用于清洁 LED 的溶剂。
- 清洁条件：IPA，最高 25℃ × 60 秒以内。
- 不建议使用超声波清洁。
- 预测试应与实际清洁过程一起进行，以验证过程不会损坏 LED。
- Do not use brushes for cleaning or organic solvents (i.e. Acetone, TCE, etc..) for washing as they may damage the resin of the LEDs.
- Isopropyl Alcohol(IPA) is the recommended solvent for cleaning the LEDs under the following conditions.
- Cleaning Condition: IPA, 25℃ max. × 60sec max.
- Ultrasonic cleaning is not recommended.
- Pretests should be conducted with the actual cleaning process to validate that the process will not damage the LEDs.

7.4 热管理条件

7.4 Thermal Management

- 热管理是深紫外 LED 封装冷却性能中最重要的部分。
- 即使从开始阶段开始，也必须认真考虑产品的散热设计。
- 发热量与输入功率之间的协同效率受电路板热阻以及 LED 布局与其他组件密度的影响。
- 深紫外 LED 应焊接在具有高导热性的金属 PCB 上。或者请将深紫外 LED 与金属 PCB、大容量散热器（Heat Block）、个空气或水冷却器等组合在一起使用。
- 请设计 LED 模块或系统，使 LED 封装的温度不超过最大结温（ T_j ）。
- The thermal management is the most important thing of the hear dissipation(cooling) performance for the deep UV(UVC) LED Package.
- The thermal design of the product must be seriously considered even from the beginning stage.
- The co-efficiency between the heat generation and the input power is affected by the thermal resistance of the circuit boards and the density of the LED placements together with other components.
- The deep UV(UVC) LED soldered on a metal PCB with a high thermal conductivity. Or Please combine the deep UV(UVC) LED with a metal PCB and a large volume-Heat Sink (Heat Block), a mini(compact / slim)-air or water cooler, etc.
- Please design the LED module or system in customer that the temperature of the LED Package does not exceed the maximum junction temperature(T_j).

7.5 人体防护

7.5 Human body protection



UVC 倒装芯片发射深紫外线，在其附近具有极高的辐射强度，这样可以快速消毒，但在此期间必须遵守安全预防措施装配和测试。

通过从制造商处购买 UVC LED，客户特此同意免除制造商因未能遵守本规范中的注意事项造成的任何身体伤害的责任。

所有装配工人，观察员和旁观者必须进行眼睛和皮肤保护。

禁止裸眼观察（包括通过显微镜）和在操作中裸露处理 UVC LED。UVC 光线很容易被污染物吸收，切勿触摸 UVC 灯珠的光学结构。

UVC flip chip emits deep ultraviolet radiation, with extremely high intensity near its surface. This allows rapid disinfection but safety precautions must be observed during assembly and testing.

By purchasing the UVC LEDs from the manufacturer, the customer hereby agrees to absolve the manufacture's responsibility of any bodily harm as a result of failure to observe the precautions, warnings and guidelines contained within this Specifications.

All assembly workers, observers and bystanders must wear eye and skin protection when the UVC LEDs are energized. Bare eye observation (including through microscopes) and bare-hand handling of a UVC LED in operation is PROHIBITED.

UVC light can be easily absorbed, so any oil or other absorbent liquid must NOT be allowed to touch the UVC-LED.

8 回流焊接

8 Reflow soldering profile

回流焊接是在电路板上组装 LED 的推荐方法。深紫科技不保证通过浸焊方法组装的 LED 的性能。

推荐的焊接条件（Sn42 / Ag1.0 / Bi57，SMIC L23-BLT5-T8F）

Reflow soldering is the recommended method for assembling LEDs on a circuit board. DUVTek does not guarantee the performance of the LEDs assembled by the dip soldering method.

Recommended soldering conditions (Sn42/Ag1.0/Bi57, SMIC L23-BLT5-T8F):

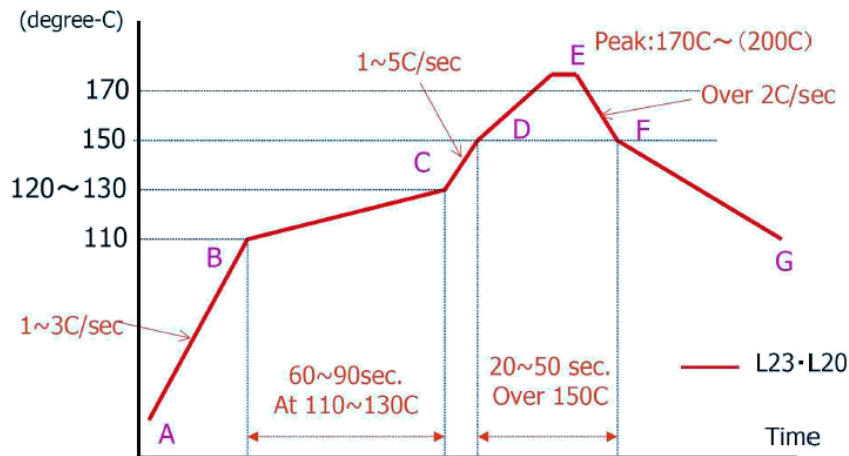

此外，深紫科技可根据客户需求提供封装后的深紫外 LED 灯珠，详情请联系销售技术人员。

In addition, DUTTEK can provide packaged UVC-LED according to customer requirements. Please contact sales technician for details.

9 附件

9.1 载带图纸（批次不同略有差异）

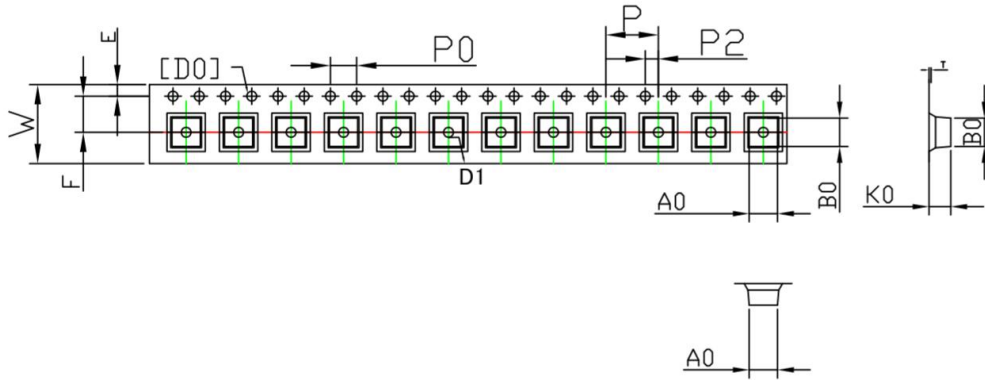

symbol	AO	BO	KO	PO	P	P2
Spec	4.20±0.1	4.20±0.1	3.25±0.1	4.0±0.10	8.0±0.1	2.00±0.10
symbol	W	T	E	F	D	D1
Spec	12.0±0.3	0.40±0.05	1.75±0.10	5.5±0.1	1.50 ^{+0.1} _{-0.1}	1.50±0.10

1. 10 孔间距累积公差为 0.2mm;
2. 载体外倾角不大于 1mm / 100mm，长度为 250mm;
3. 所有尺寸符合 EIA-481-B 要求;
4. 材料：导电聚酯聚苯乙烯系塑料。

1. 10 Sproket hole pitch cumulative tolerance is 0.2mm;
2. Carrier camber shall be not more than 1mm per 100mm Through a length of 250mm;
3. All dimensions meet EIA-481-B Requirements;
4. Material:Conductive Polyester PS.

9.2 推荐焊盘设计图纸

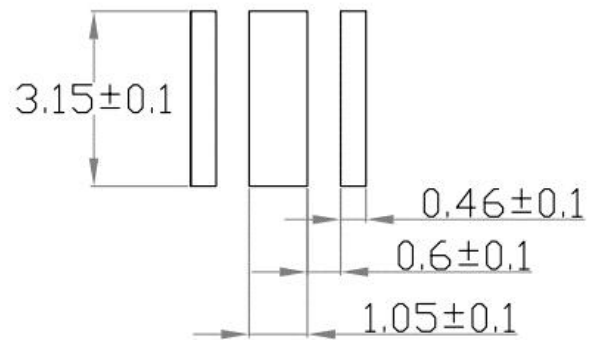

1. 该推荐焊盘设计可以兼容我司 SWC、QWC 及 QSC 系列产品的贴片要求。
1. The recommended pad design is compatible with the placement requirements of our SWC, QWC and QSC series products.